

VERTICAL SHIPLAP WEATHER BOARDS

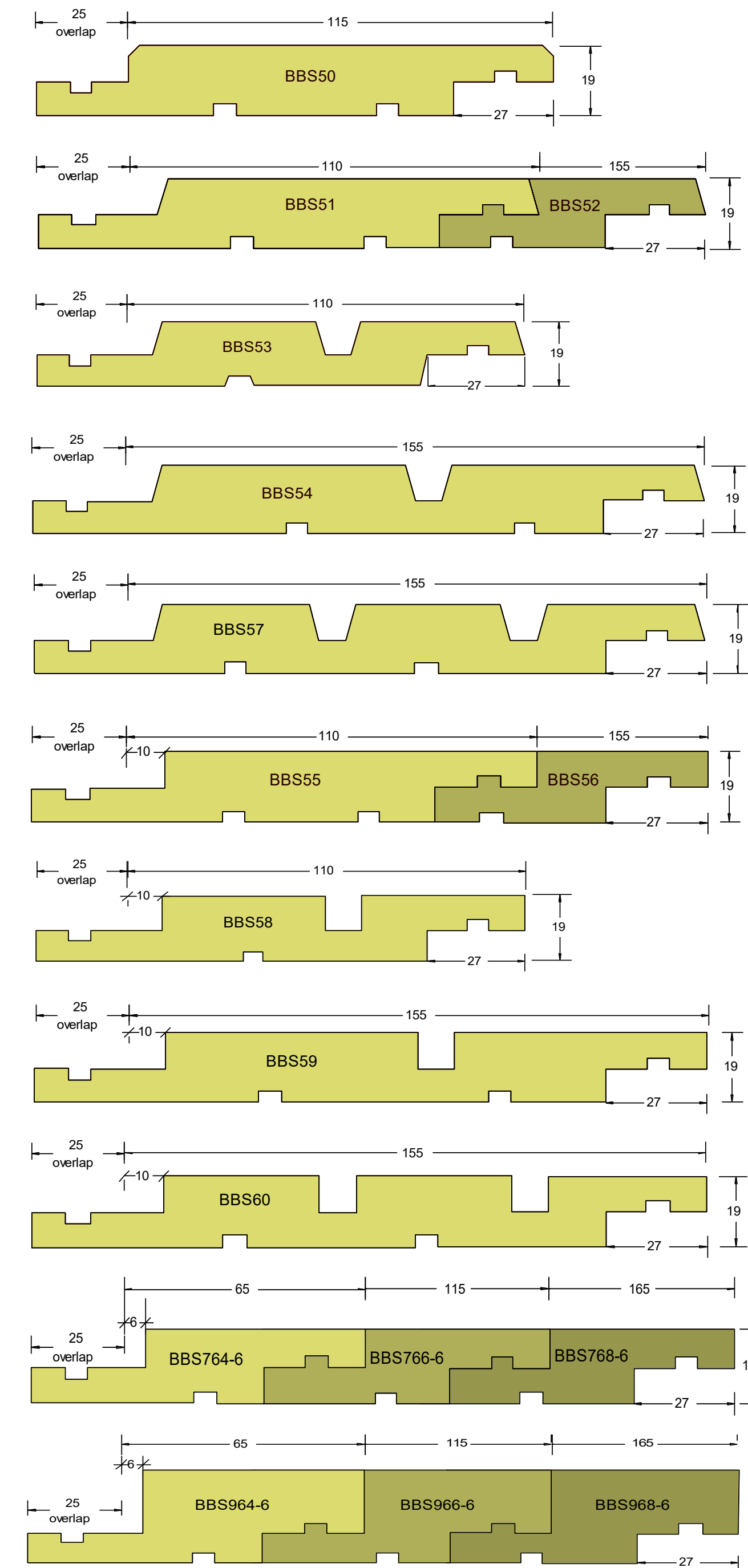

FASCIA BOARDS

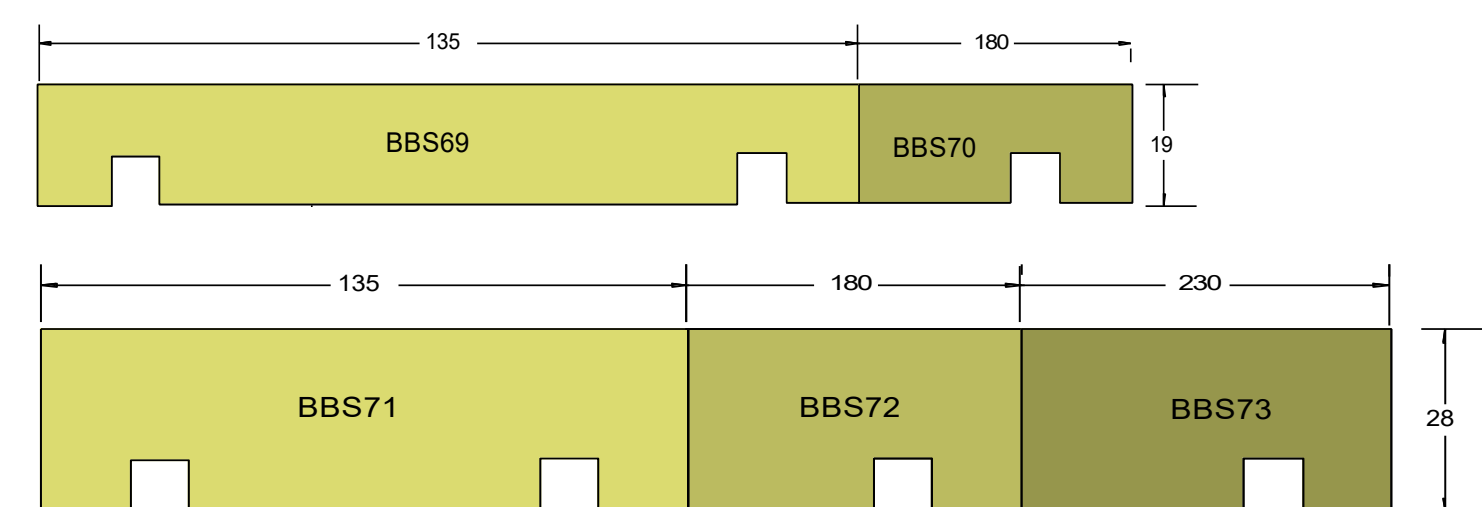

NOTES:

- Weatherboards are supplied in Western Red Cedar, STK Cedar and H3.2 Radiata Pine.
- Bandsawn Face (BSF) or Dressed Face (DF) are available in all Profiles.
- Profiles on this chart are not to scale.
- End matching available where applicable.
- BBS Factory applied Finishes available on all Timber Profiles

HORIZONTAL RUSTICATED WEATHER BOARDS

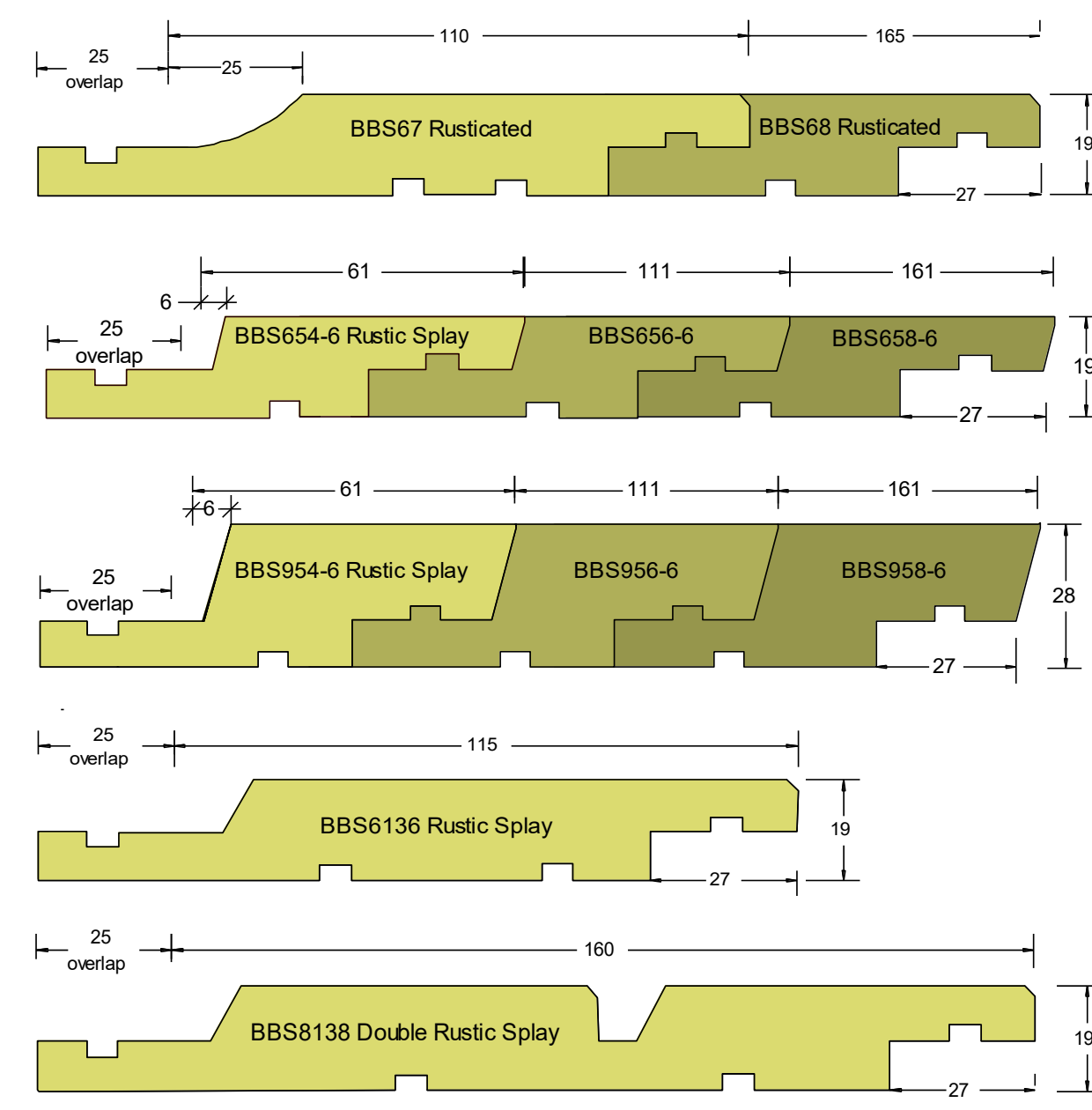

HORIZONTAL BEVEL BACK WEATHER BOARDS

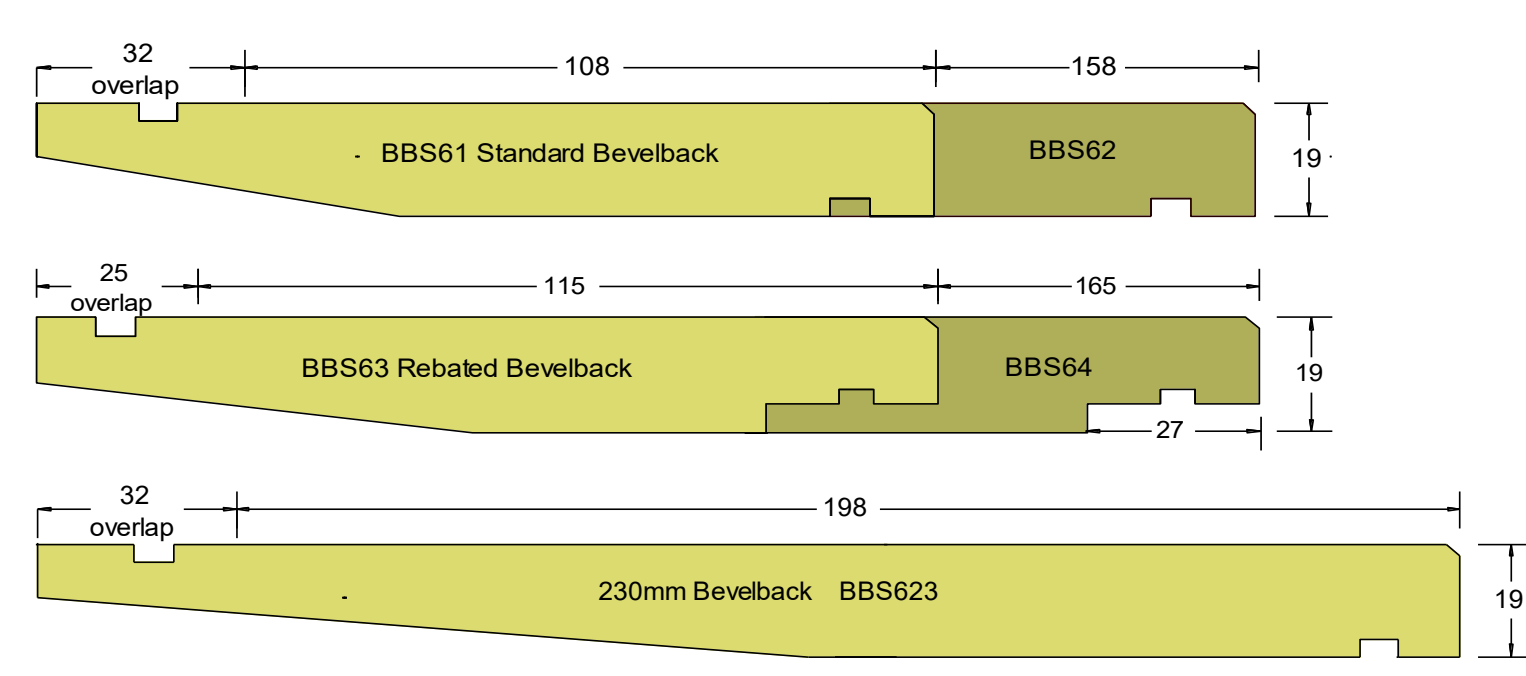

HORIZONTAL SPLAYCUT WEATHER BOARDS

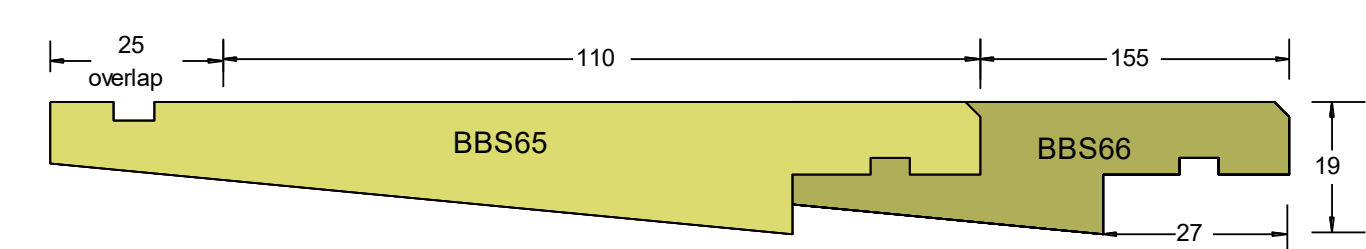

BOARD & BATTEN WEATHERBOARDS

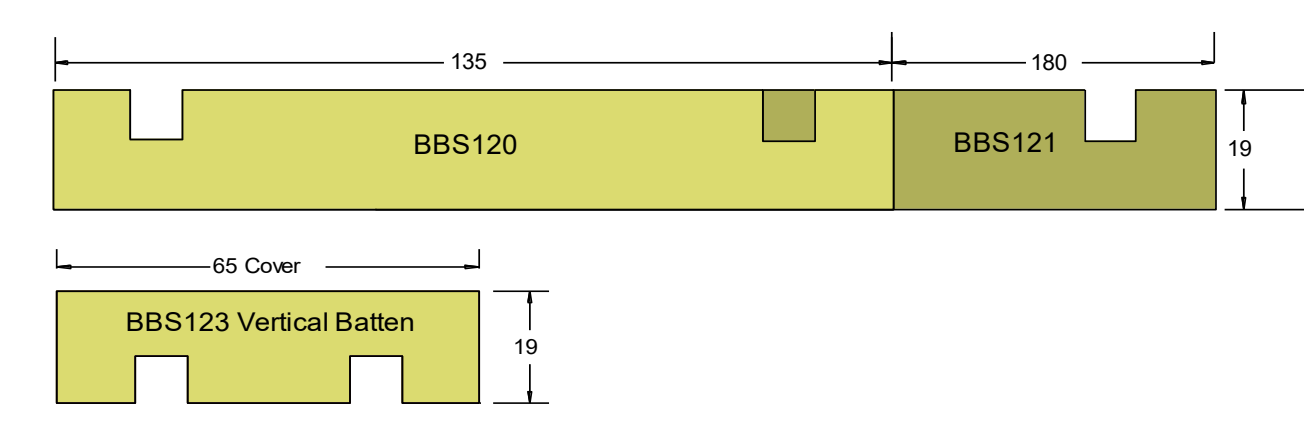

TIMBER DECKING

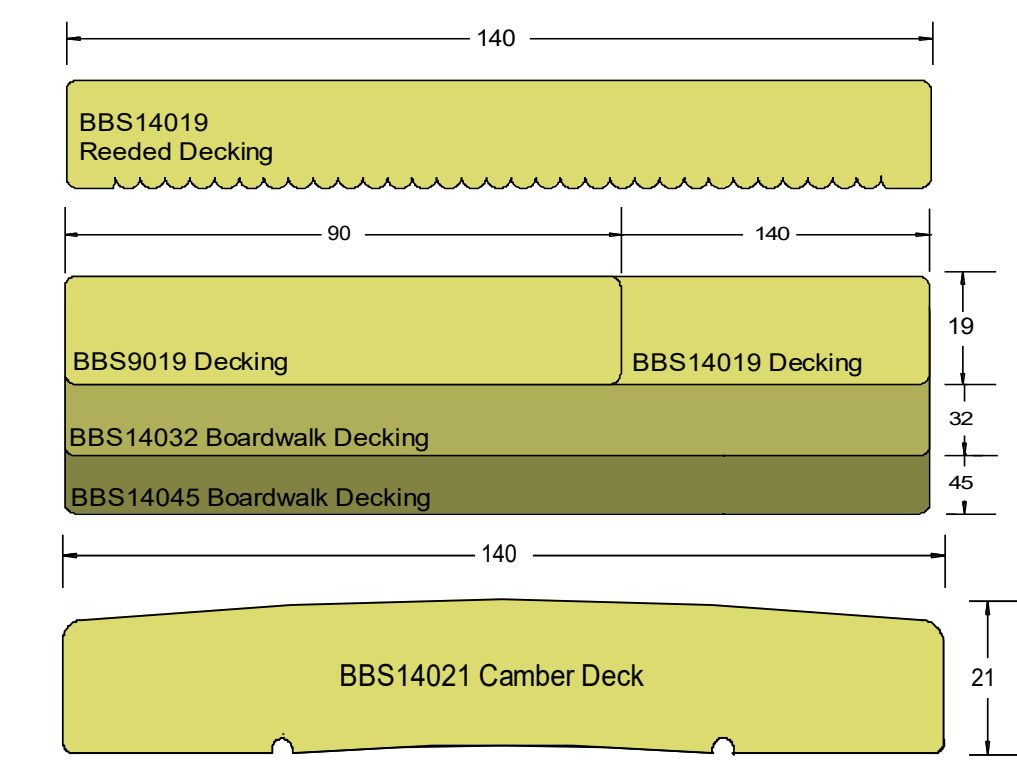

PANELLING & SARKING

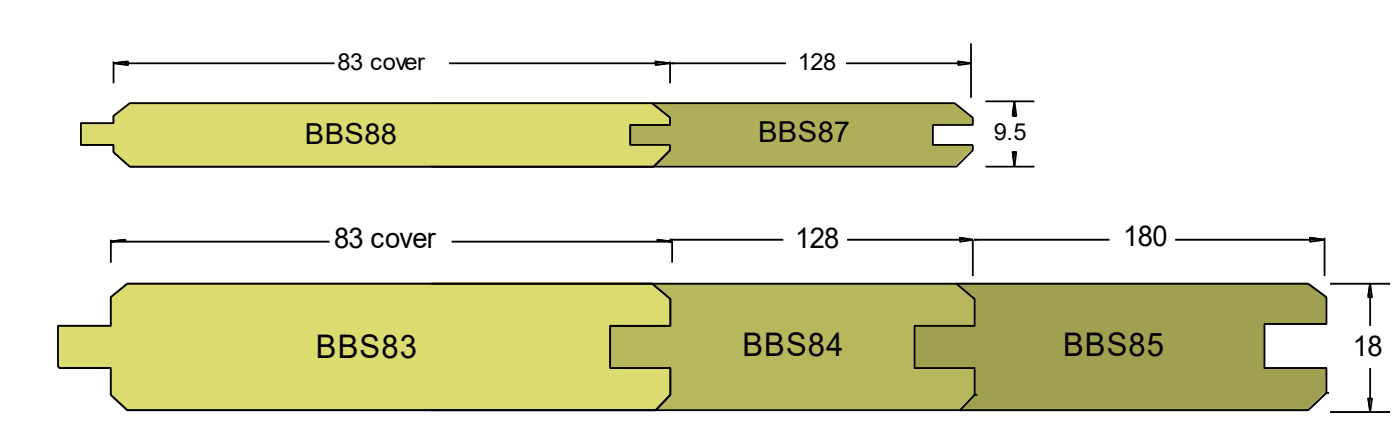

REBATED PANELLING

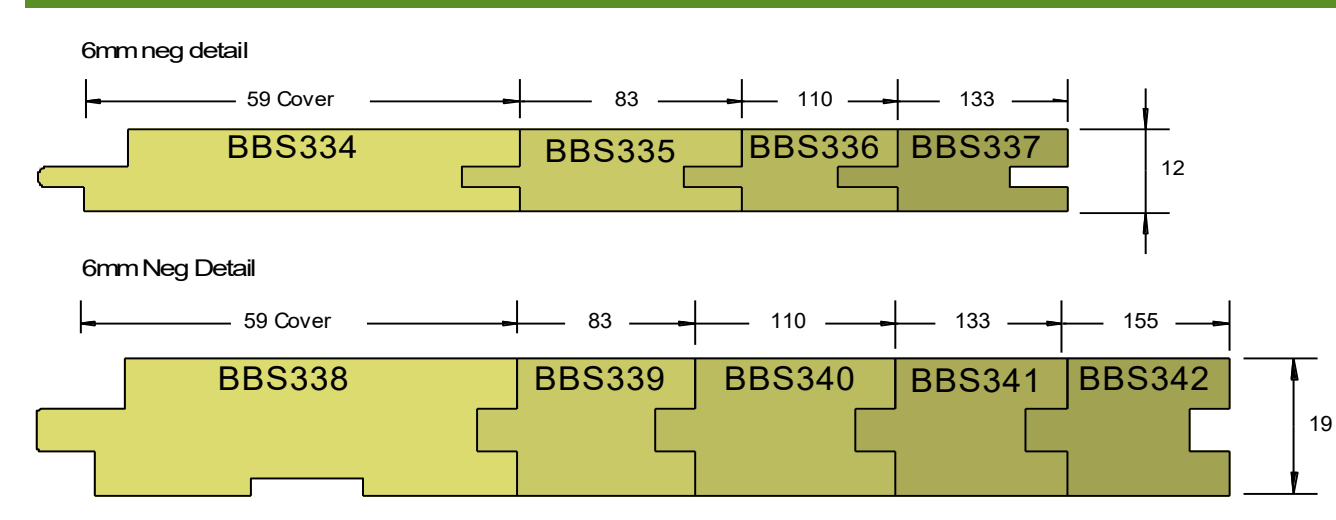

TONGUE & GROOVE FLOORING

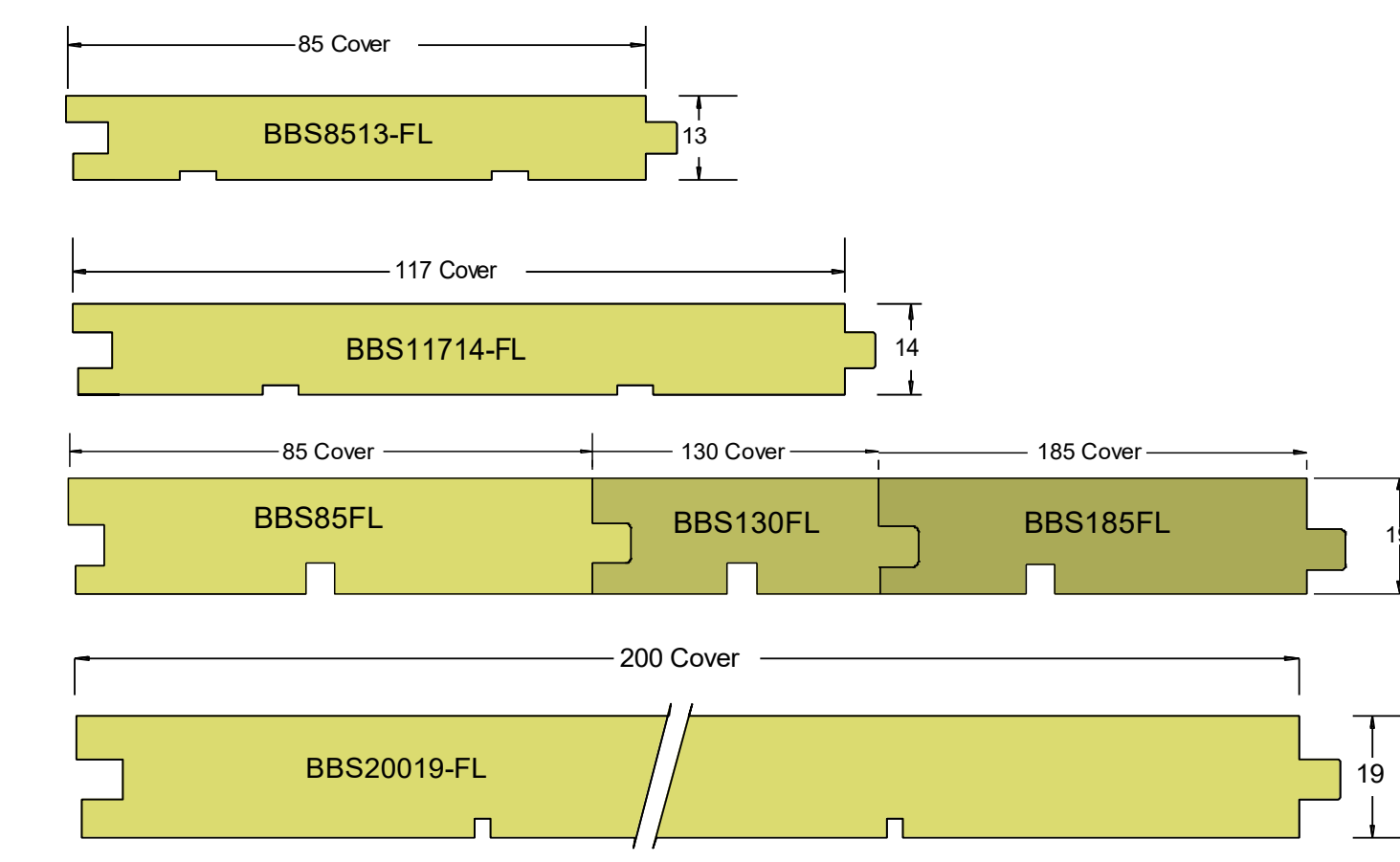

EXTERIOR MOULDINGS

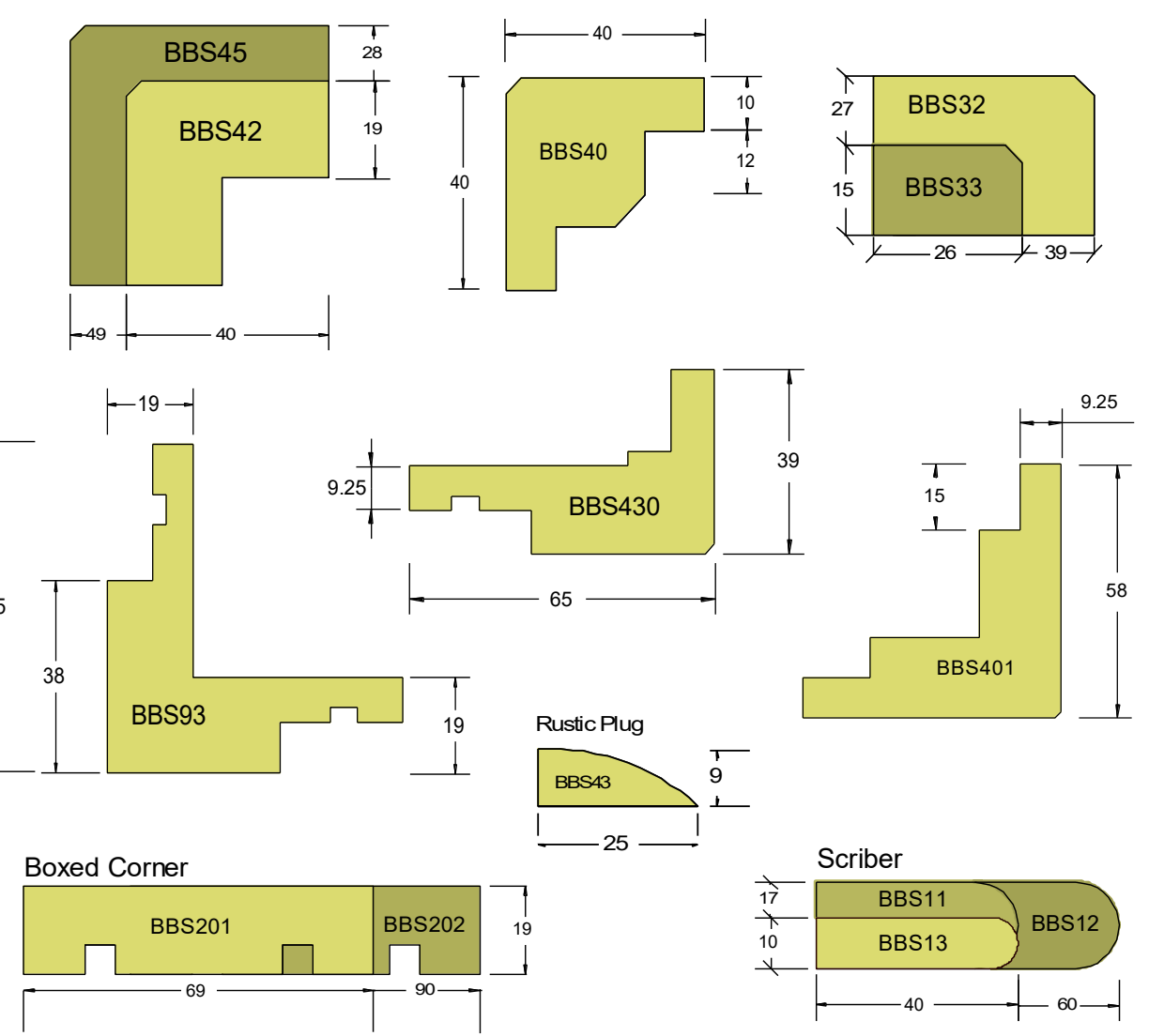

INTERNAL MOULDINGS

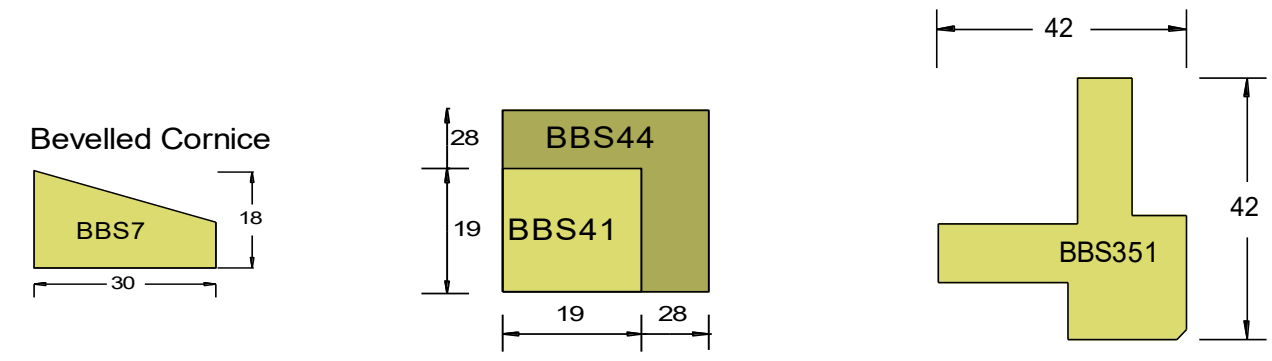

DECK FIXINGS



Size	DRIVE	Pack Size
10g x 65mm	STAR	400
10g x 65mm	SQUARE	400
12g x 65mm	STAR	300

CLADDING NAILS & ACCESS-

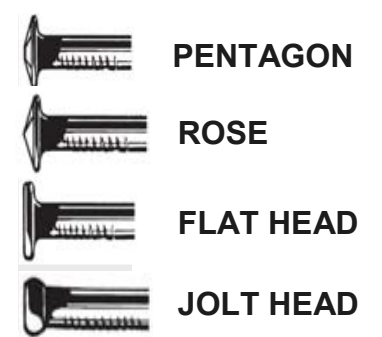

Size	No. Per Kilo	Pack Sizes
100x4.00	90	500g 2kg 5kg
85x3.25	150	
75x3.25	175	
60x3.25	220	
50x2.80	360	

Size	No. Per Kilo	Pack Sizes
100x4.00	95	500g 2kg 5kg
85x3.15	188	
75x3.15	215	
60x3.15	260	
50x2.80	390	

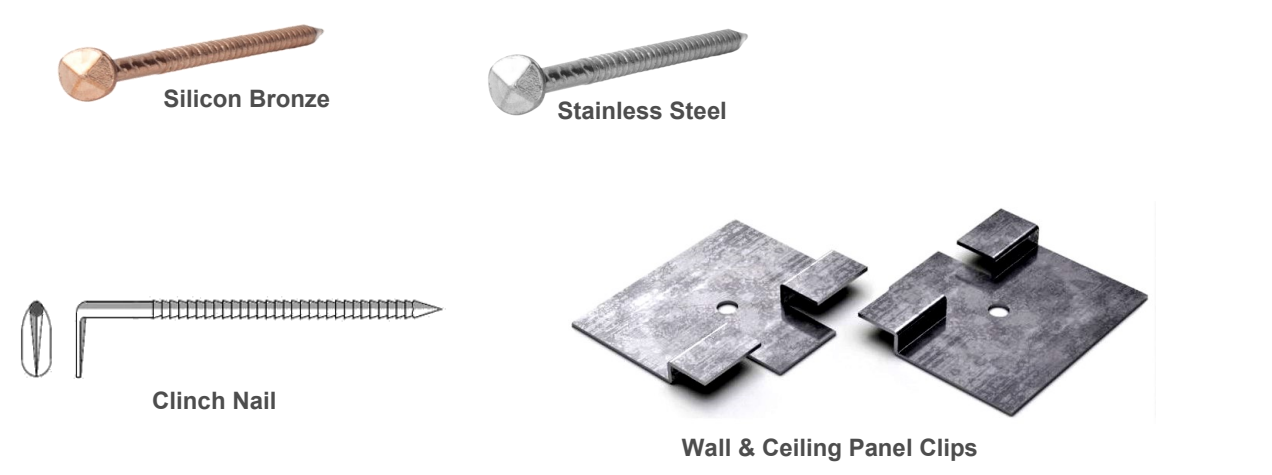

DRESSED 4 SIDE BOARDS / BANDSAWN 4 SIDES

