

### VERTICAL SHIPLAP WEATHER BOARDS

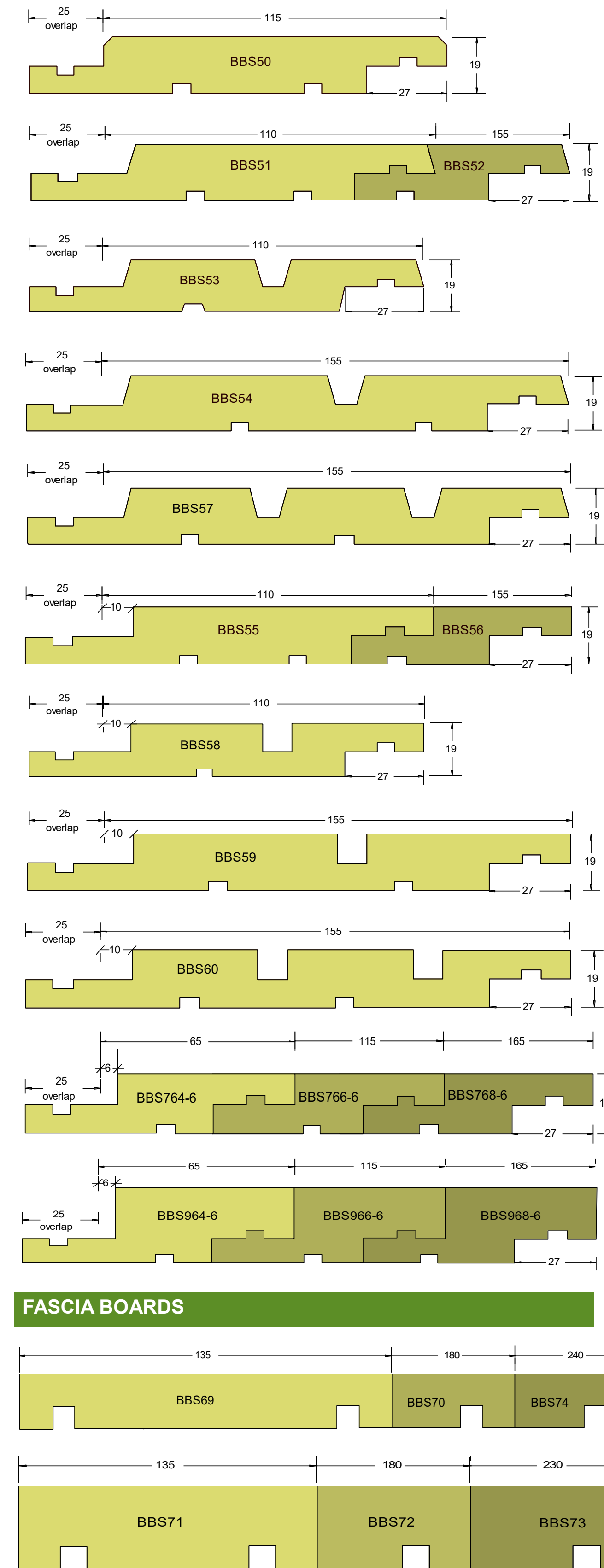

### FASCIA BOARDS

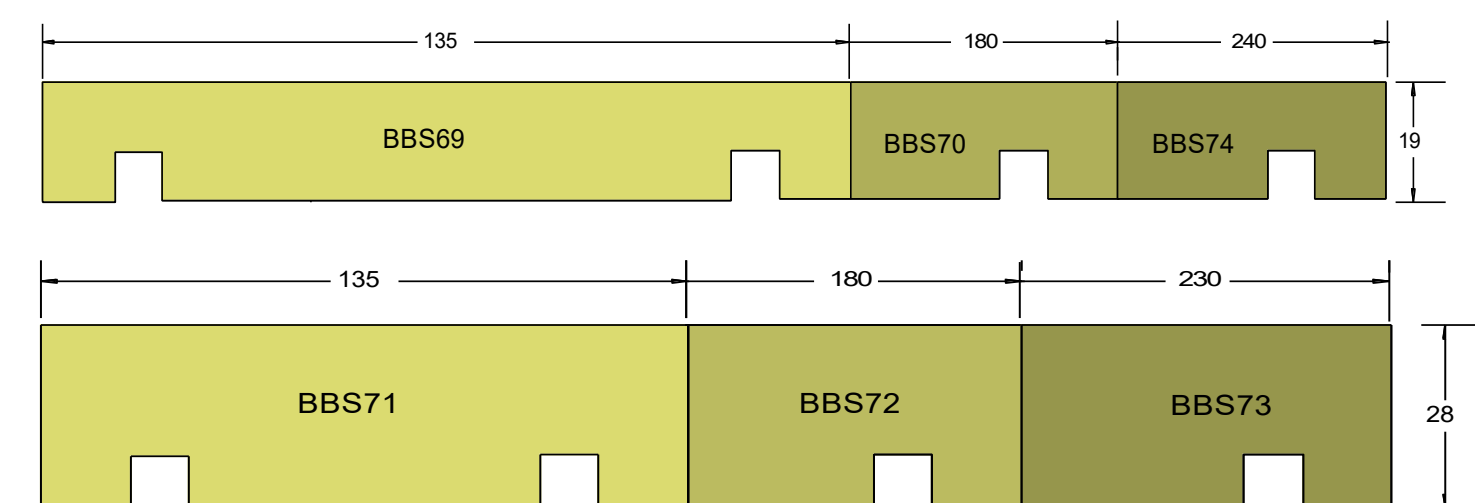

### NOTES:

- Weatherboards are supplied in Western Red Cedar, Yellow Cedar, STK Cedar and H3.2 Radiata Pine in Bandsawn Face (BSF) or Dressed Face (DF)
- We can match other profiles and special runs on request.
- End matching available where applicable.
- BBS Factory applied Finishes available on all Timber Profiles
- Profiles on this chart are NOT TO SCALE

### HORIZONTAL RUSTICATED WEATHER BOARDS

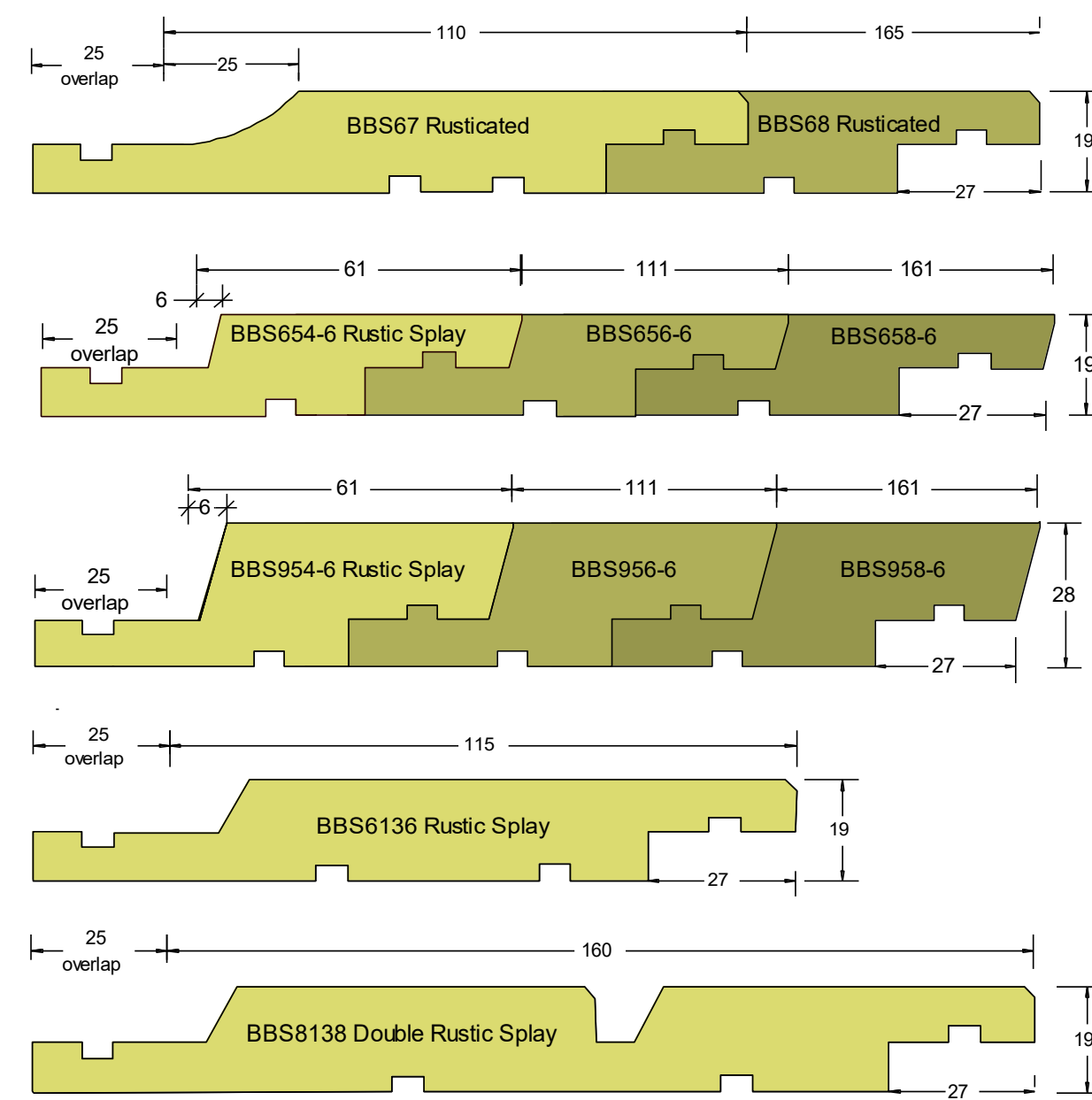

### HORIZONTAL BEVEL BACK WEATHER BOARDS

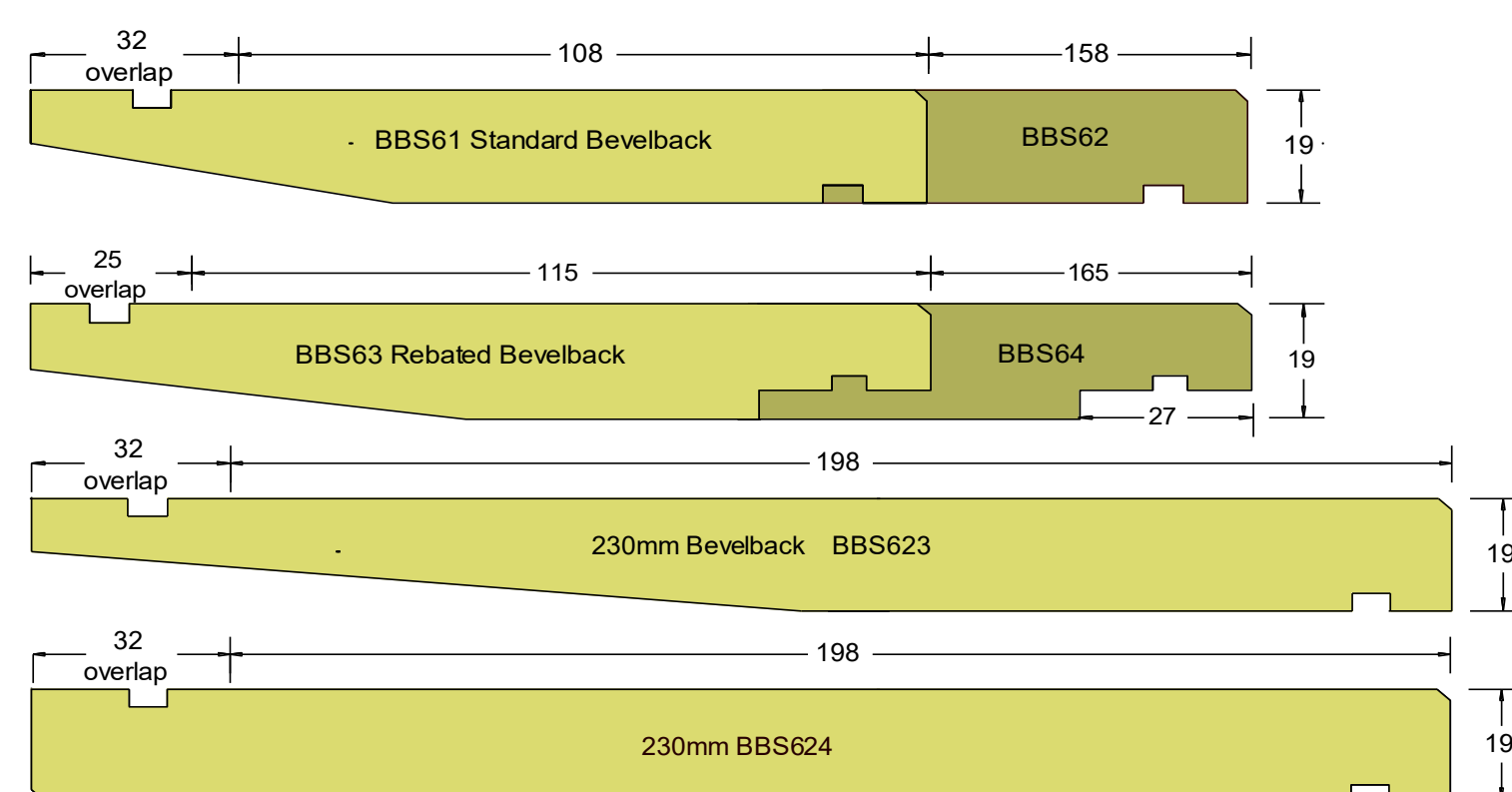

### HORIZONTAL SPLAYCUT WEATHER BOARDS

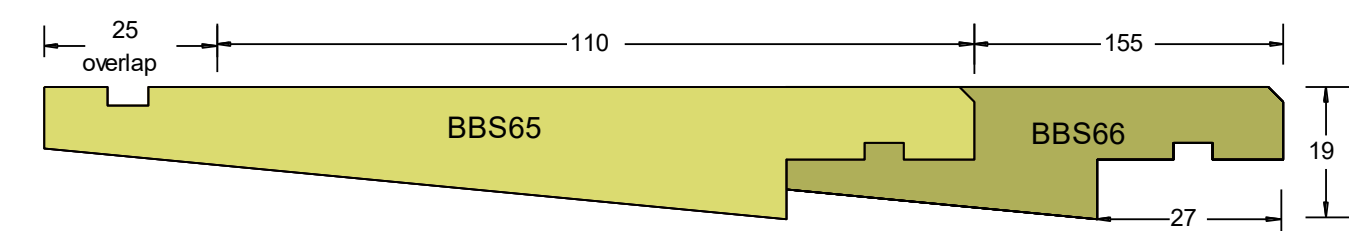

### BOARD & BATTEN WEATHERBOARDS

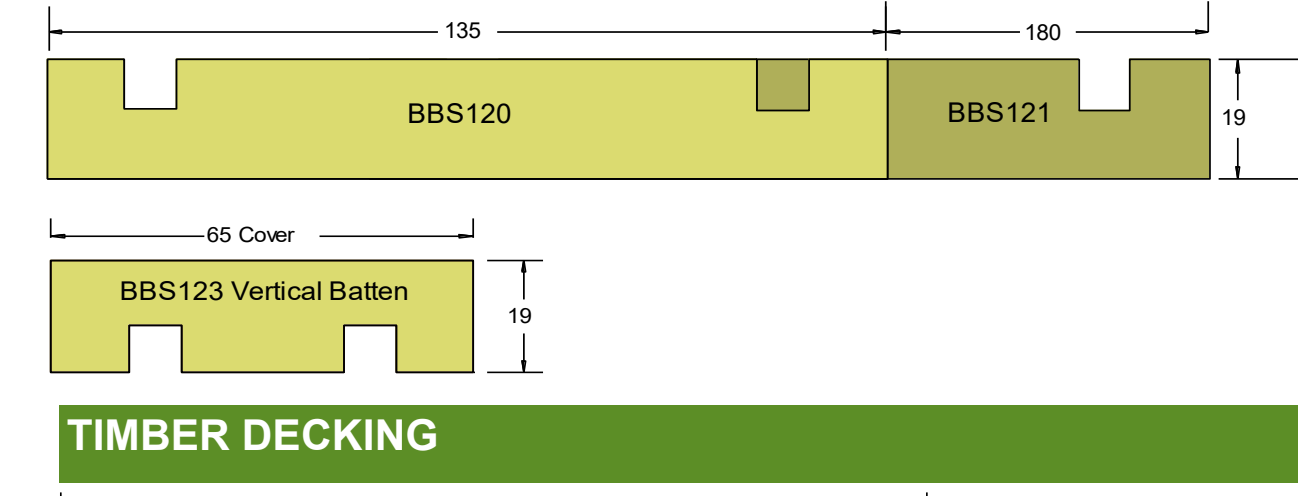

### TIMBER DECKING

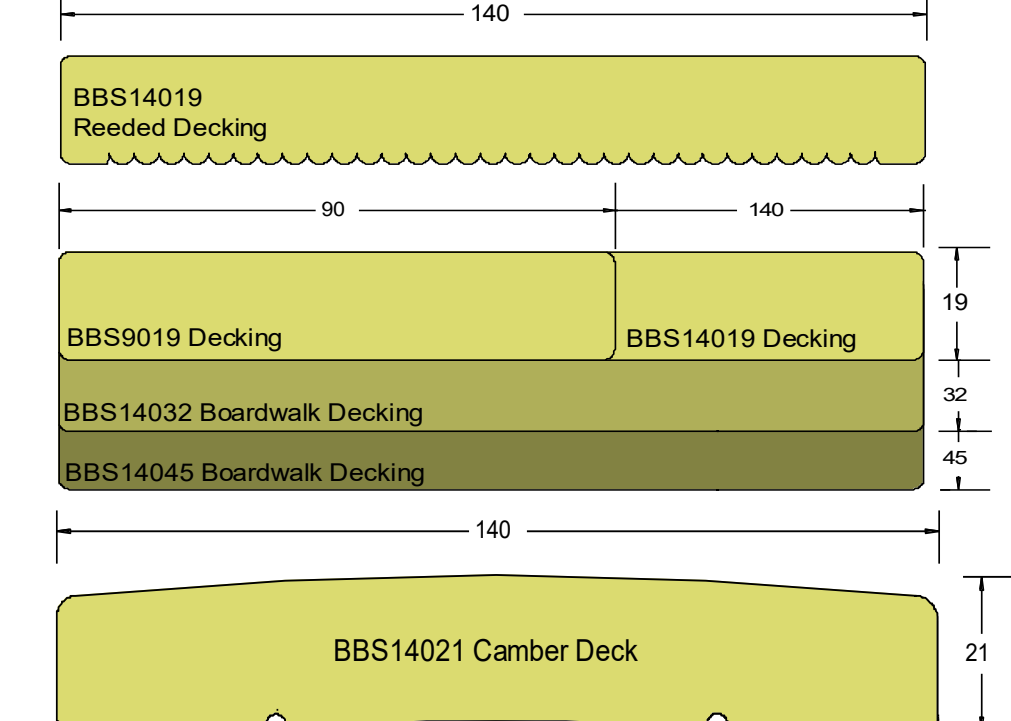

### PANELLING & SARKING

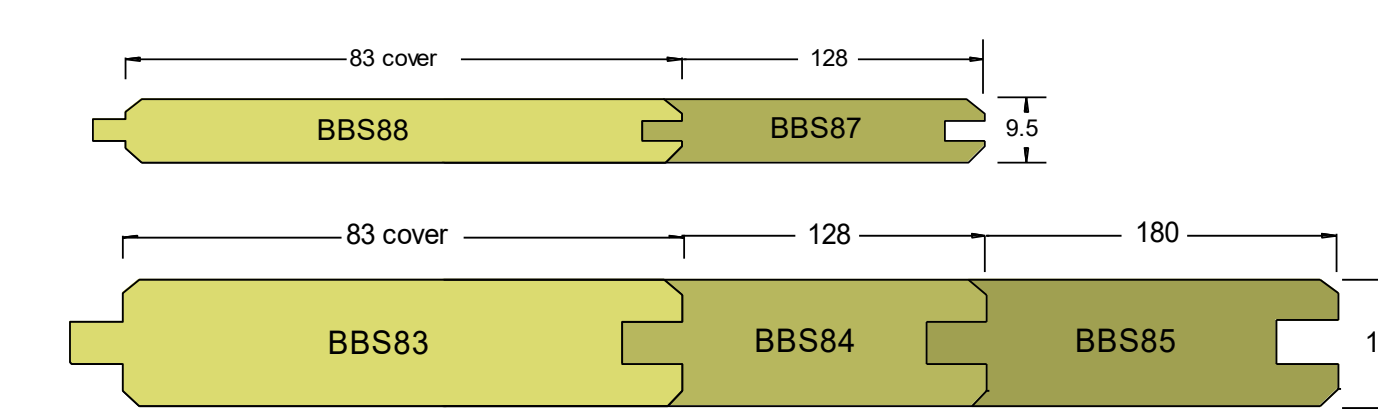

### REBATED PANELLING

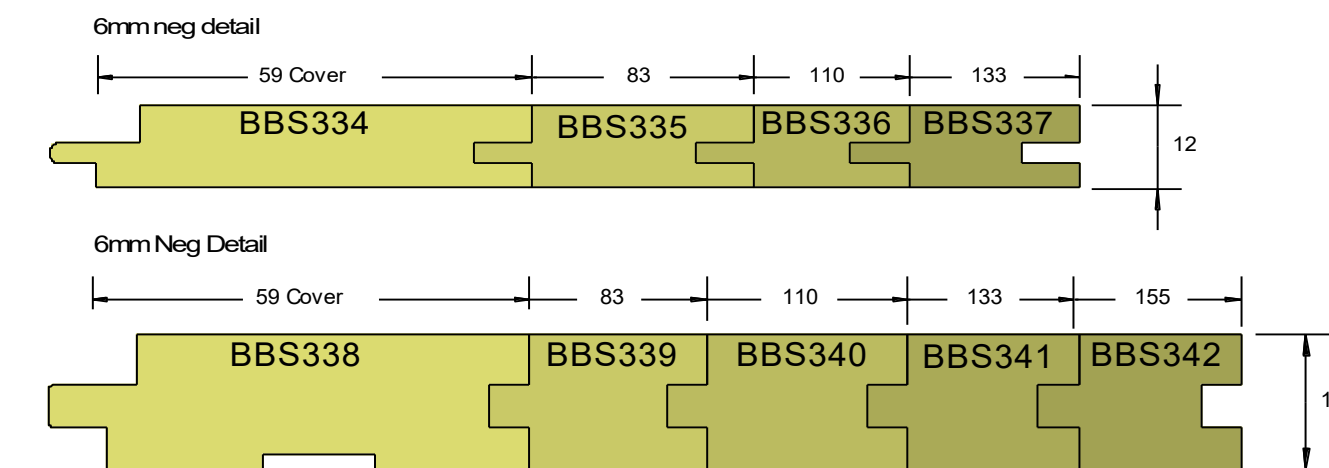

### TONGUE & GROOVE FLOORING

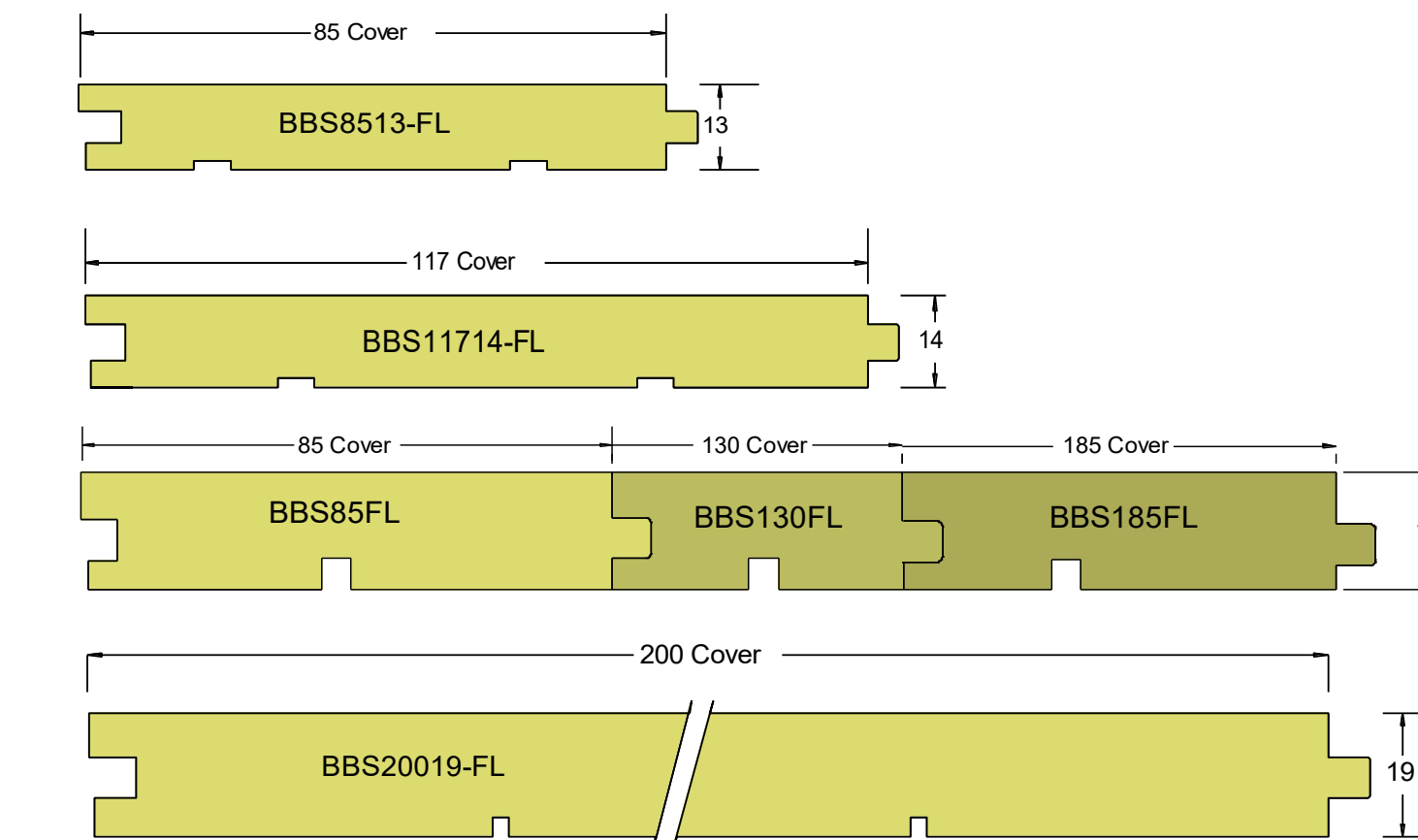

### EXTERIOR MOULDINGS

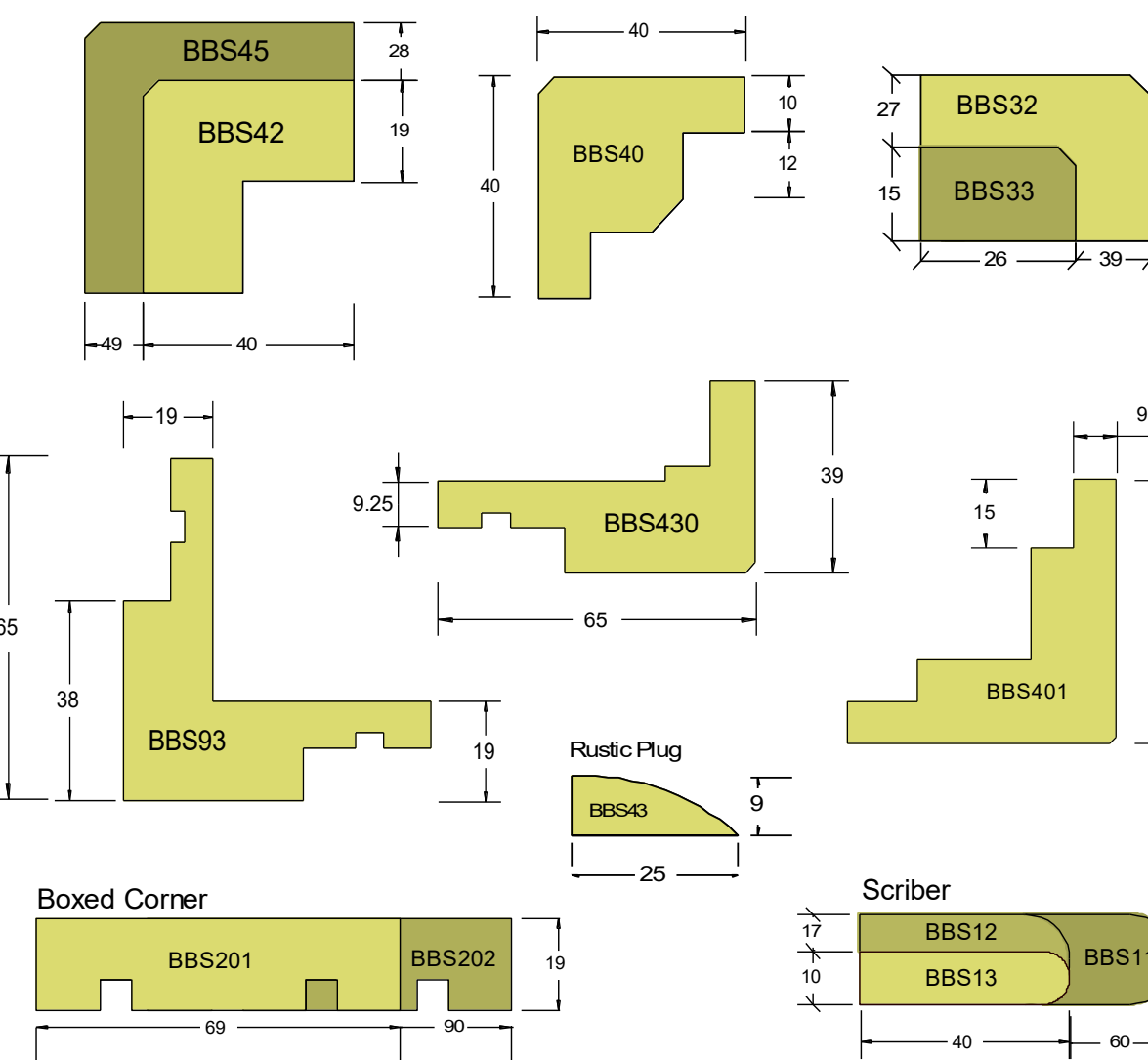

### INTERNAL MOULDINGS

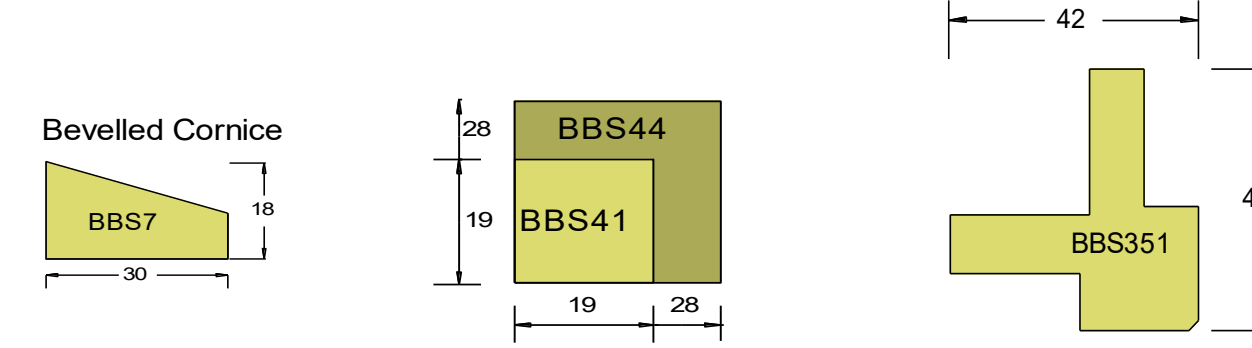

### DECK FIXINGS



Stainless Steel SCREWS (316 grade) STAR or SQUARE drive, double thread

Size	DRIVE	Pack Size
10g x 65mm	STAR	400
10g x 65mm	SQUARE	400
12g x 65mm	STAR	300

### CLADDING NAILS & ACCESSORIES

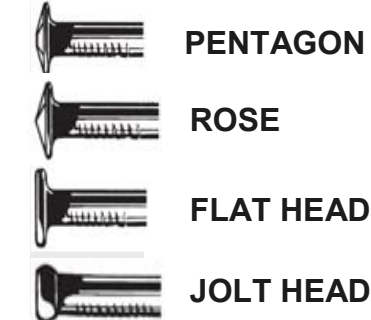

Silicon Bronze AG Nails

Size	No. Per Kilo	Pack Sizes
100x4.00	90	500g 2kg 5kg
85x3.25	150	
75x3.25	175	
60x3.25	220	
50x2.80	360	

Stainless Steel AG Nails 316 grade

Size	No. Per Kilo	Pack Sizes
100x4.00	95	500g 2kg 5kg
85x3.15	188	
75x3.15	215	
60x3.15	260	
50x2.80	390	

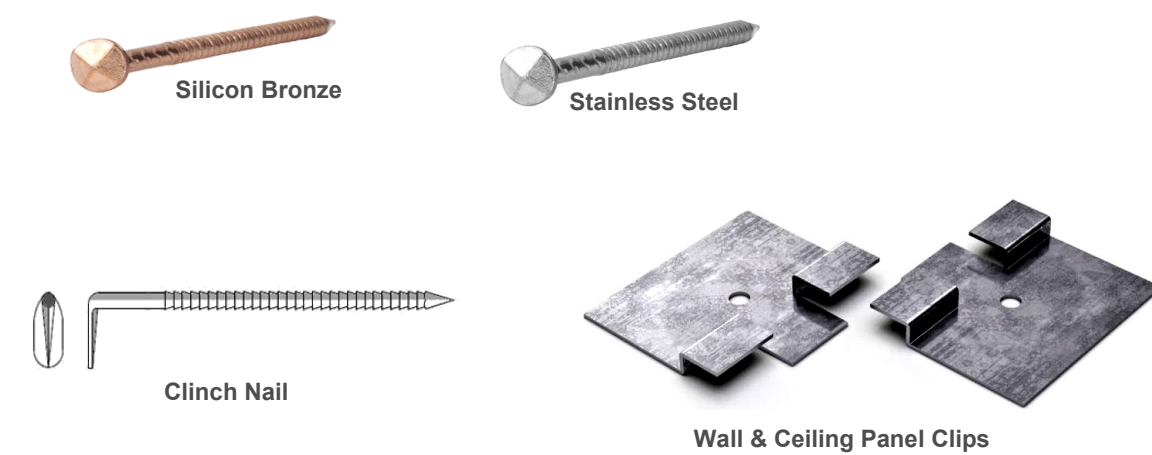

### DRESSED 4 SIDE BOARDS / BANDSAWN 4 SIDES

